

REV:	DESCRIPTION	BY	DATE
V1.0	New issue	Mike	2015-12-31

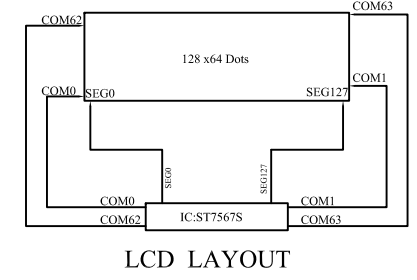

NO	Symbol
1	P/S
2	C86
3	VG
4	V0
5	XV0
6	VSS
7	VDD
8	DB7
9	DB6
10	DB5
11	DB4
12	DB3
13	DB2
14	DB1
15	DB0
16	E/RD
17	RW/WR
18	RS
19	/RES
20	/CS1

- NOTES :
- | | |
|---|---|
| 1. LCD TYPE: | FSTN, Positive Transflective |
| 2. OPERATING VOLTAGE: | VDD=3.0V, Vop=9.45V |
| 3. VIEWING DIRECTION: | 6 O'CLOCK |
| 4. DRIVE METHOD: | 1/65 Duty, 1/9 Bias |
| 5. OPERATING TEMP: | -20°C TO +70°C |
| 6. STORAGE TEMP: | -30°C TO +80°C |
| 7. CONNECTOR TAPE: | COG+20 Pin |
| 8. DRIVER IC: | ST7567S |
| 9. BACKLIGHT: | 1 pcs LED White, VF=3.1±0.2V, IF=15mA |
| 10. ALL sub-parts and materials of the parts, | must comply with the RoHS instructions of EU. |

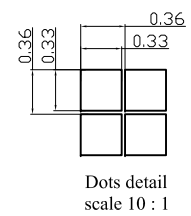
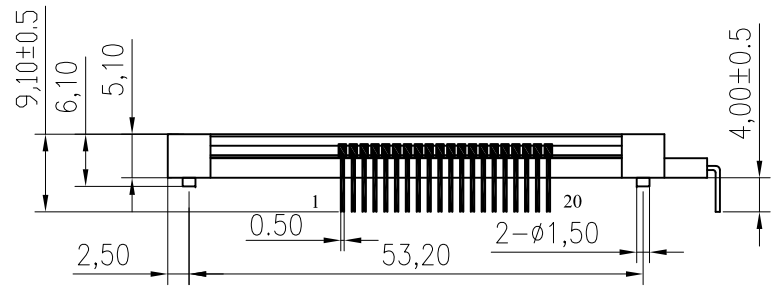
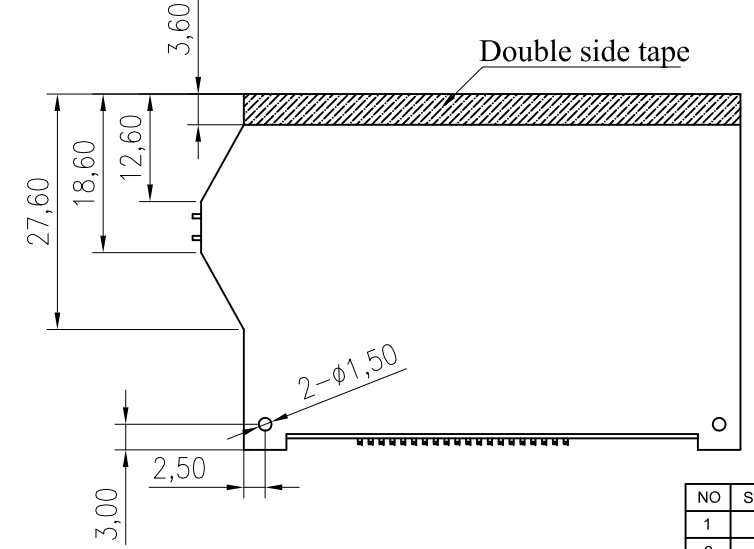
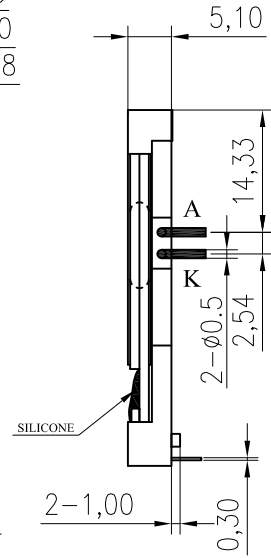
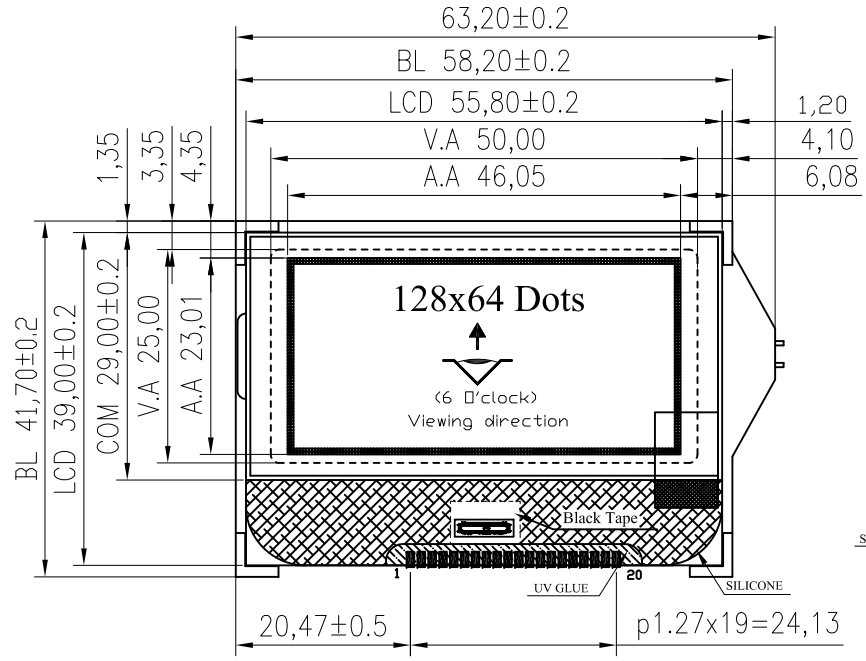
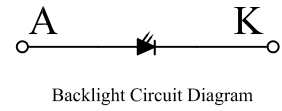

SINDA DISPLAY TECHNOLOGY CO., LTD.		VERSION: 1.0		UNITS:	
		GENERAL TOL: ± 0.2		MM	
SHEET: 1 of 1		MODEL NUMBER : SDGG12864-58		DO NOT SCALE THIS DRAWING.	
APPROVALS	DATE	www.sindadisplay.com		SCALE: 1:1	
DWN Mike	2015-12-31				
CHK					
APP CJ	2015-12-31				